

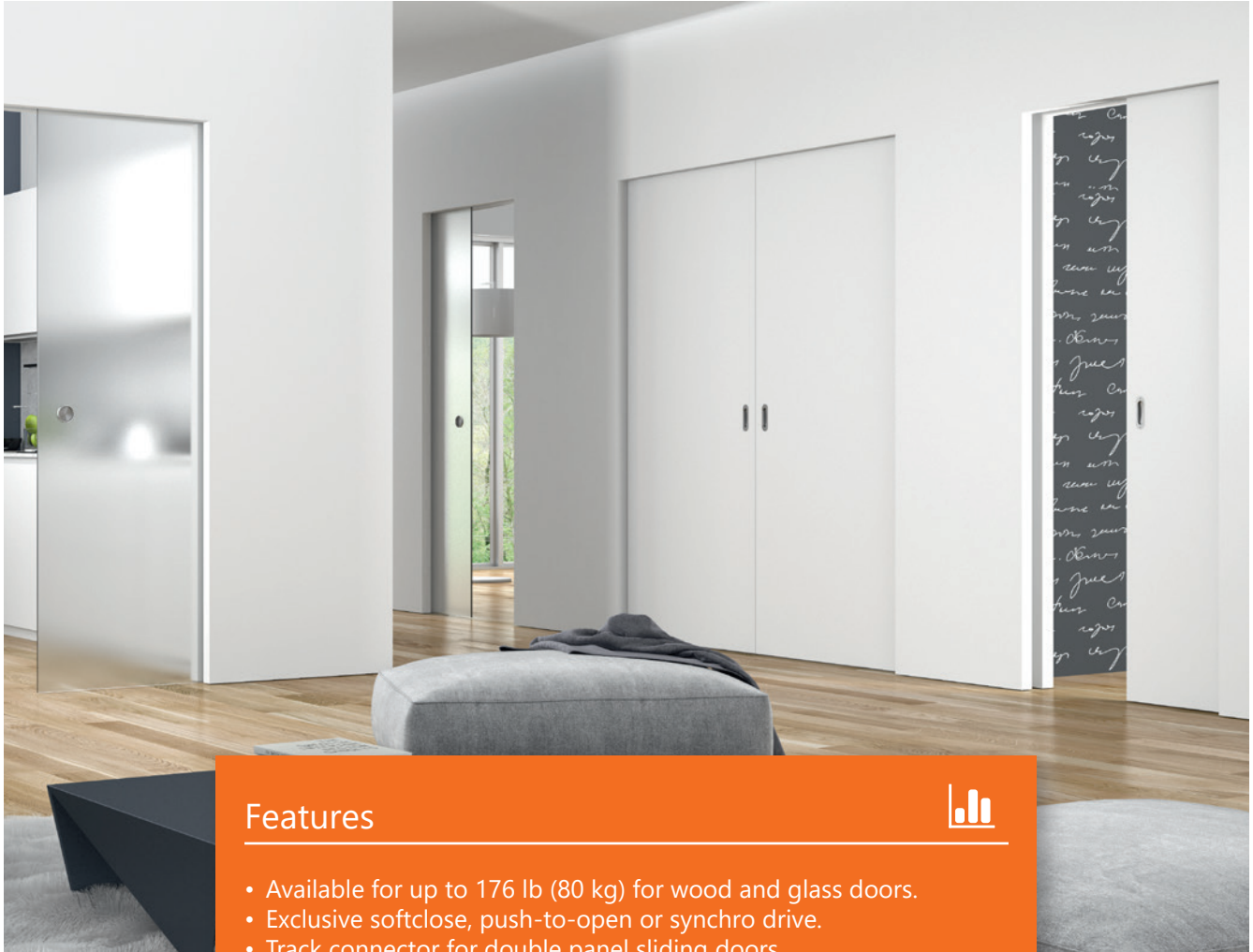

SMART track

Sliding door hardware
For wood and glass doors
Up to 176 lb door weight

Features-Advantages



Features



- Available for up to 176 lb (80 kg) for wood and glass doors.
- Exclusive softclose, push-to-open or synchro drive.
- Track connector for double panel sliding doors.
- Optional recessed hardware for wood doors and glass clamps with valance for more clearance height.
- Optional wall mounting profile
- Aluminium valances to clip on the track profile

Advantages



- Modern design
- Quick and easy door installation and adjustment after track/wall install
- Exchange components without opening the finished wall
- Due to the wheel sets there is only a minimal friction and a smooth movement guaranteed.
- The SMARTtrack can be customized in every detail to individual needs. Even when installed!
- Outstanding sliding properties.

Technical features

Basic sliding door hardware set for one wood door panel

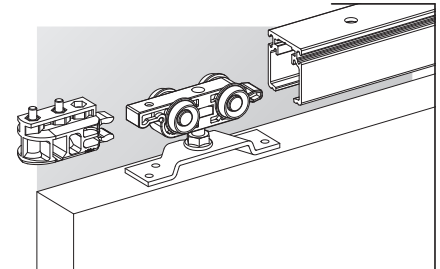

Wheel set and stopper - two pieces per door. The wheel bracket is mounted to the door panel, the stopper to the track. The door can be removed and attached while the track remains installed.

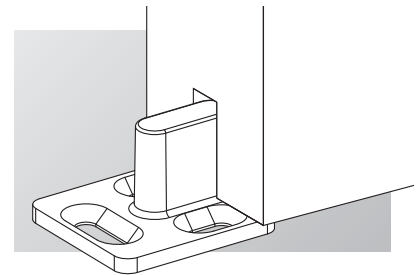

Floor guide - for wood doors, screwed into or glued to the floor.

- For ceiling mounting.
- Lengths available up to 78 ¾" (2000 mm) & 118 ½" (3000 mm).
- Up to 176 lb (80 kg) door weight.
- Fits to 1 ¾" (35 mm) or 1 ⅝" (45 mm) thick door panels.
- For door widths from 24" (610 mm) up to 58" (1475 mm).

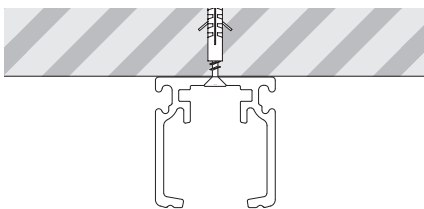

Track for ceiling mounting includes access opening for adjustment.

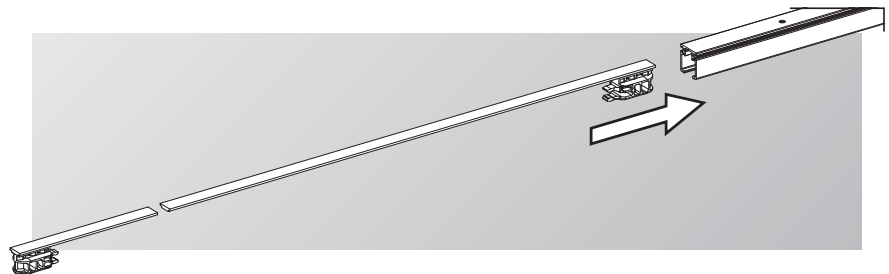

Stopper adjustment mechanism for easy adjustment or replacement of stoppers when installed. The finished wall does not need to be opened.

Glass clamp set for glass doors

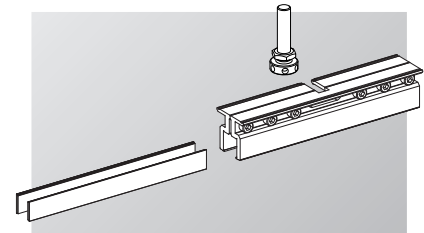

Converting the basic wheel set to glass doors
- two glass clamps with slide-in clamping pads for different glass thicknesses and two height adjustment screws.

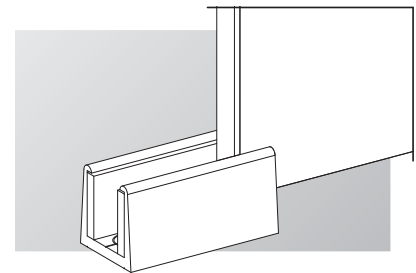

Floor guide - for glass doors, screwed into the floor.

- Accessory set for tempered glass and laminated safety glass
- Suitable for $\frac{3}{8}$ " (10/10,76 mm) and $\frac{1}{2}$ " (12/12,76) glass thickness.
- Up to 176 lb (80 kg) door weight.
- Floor guide with similar to stainless steel or black finish.

Technical features

Recessed wood door mount

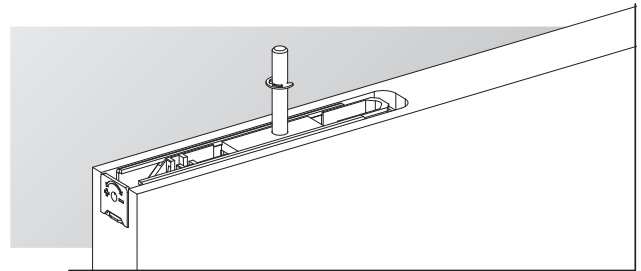

- The basic hardware set for wood sliding doors can also be combined with a recessed door mount.
- Up to 176 lb (80 kg) door weight.
- No maintenance valance required.

Glass clamp set with valance

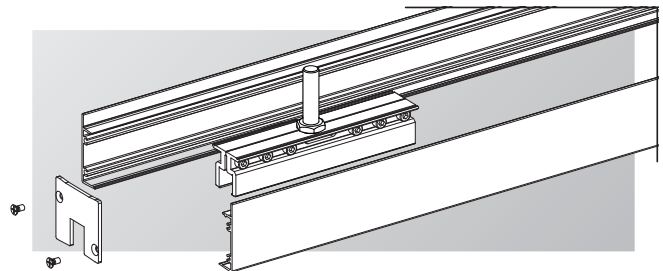

- The basic hardware set for wood sliding doors can also be combined with glass clamps with valance.
- Up to 176 lb (80 kg) door weight.
- No maintenance valance required.

Wall mounting profile



- Aluminium profile for wall mounting.
- The track is just clipped onto the wall mounting profile.

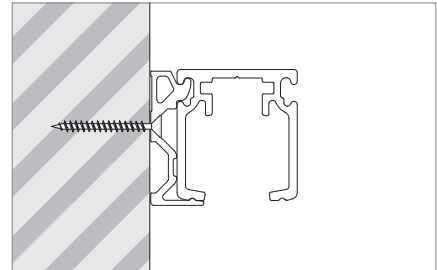

Valance profile for wood doors



- Mounts to top track
- On-site finishing not required
- Aluminum, stainless steel or black look
- Including two end caps for the sides

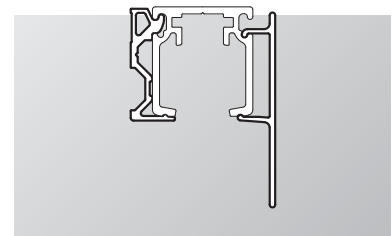
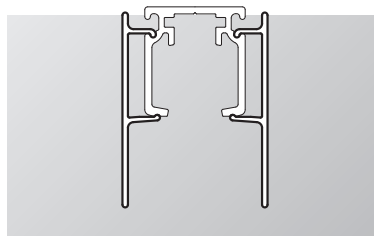

Valance profile - double sided mounting for ceiling mounted systems, single side mounting for wall mounted systems

Valance profile for glass doors



- Mounts to top track
- On-site finishing not required
- Aluminum, stainless steel or black look
- Including two end caps for the sides

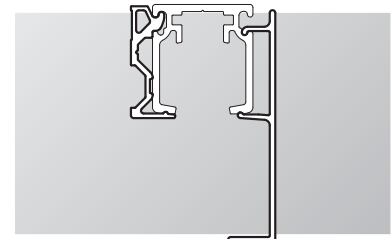
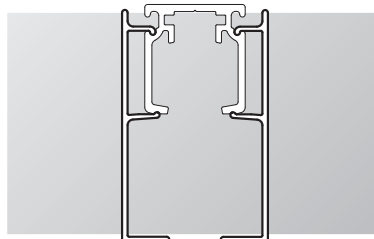

Valance profile - double sided mounting for ceiling mounted systems, single side mounting for wall mounted systems

Technical features

Softclose

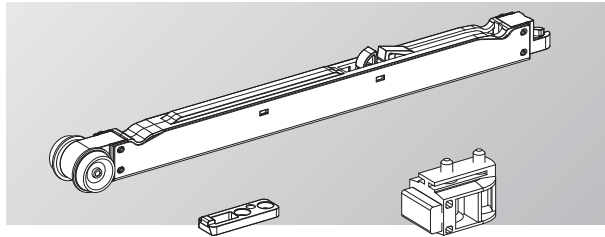

- For gentle door closing
- Maximum weight of 176 lb (80 kg)
- Minimum door width of 24" (610 mm) when used on one side
- Minimum door width of 34" (860 mm) when used on both sides

Push to open

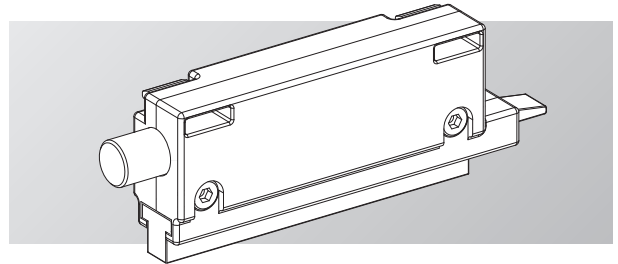

- For mounting on the pocket side of the track
- Maximum weight of 176 lb (80 kg)
- Minimum door width of 24" (610 mm)
- Can be combined with one-sided soft close on the passage side when the door is at least 26" (660 mm) wide

Synchro for wood doors

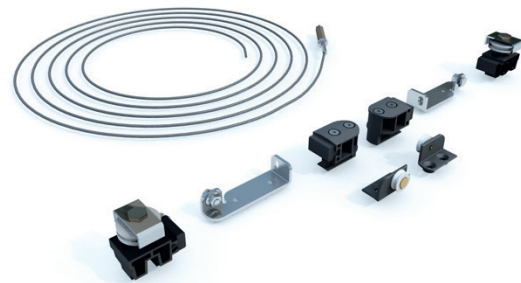

- Both doors can open and close simultaneously using a cable
- For two wood doors up to 176 lb (80 kg) per door panel
- Comfortable operation with one hand

Sliding track connector

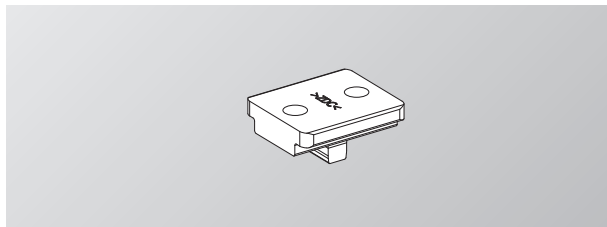

- For a comfortable alignment of two sliding tracks to install double panel sliding doors (biparting).

256 lb wheel set

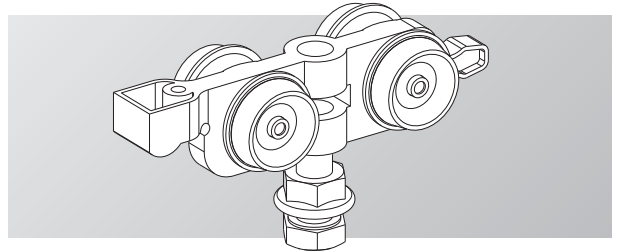

- Heavy duty zinc die cast wheel set for door weights up to 265 lb. (maximum door weight stays at 176 lb (80 kg) when the wall mounting profile is used)

Drawings and formulas

Sliding door hardware for wood doors

Side view

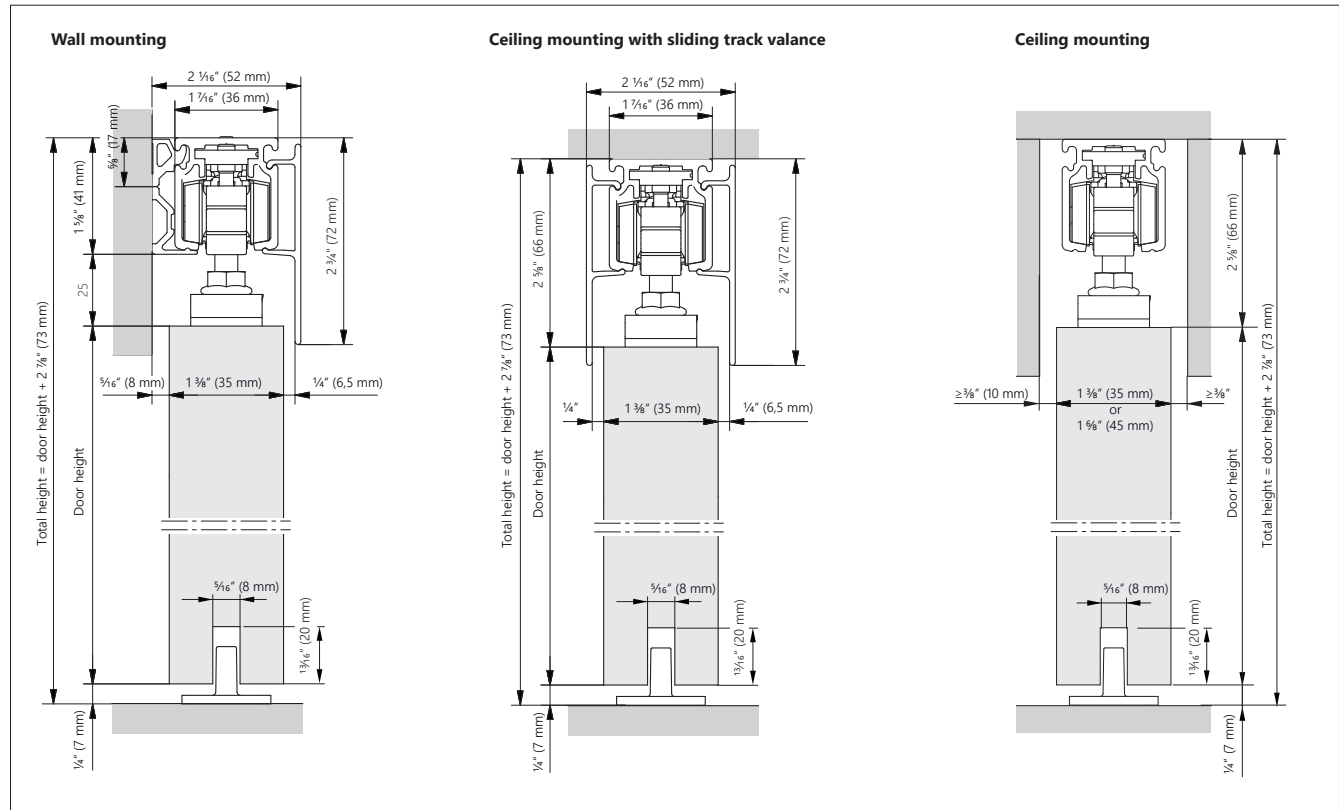

Front view

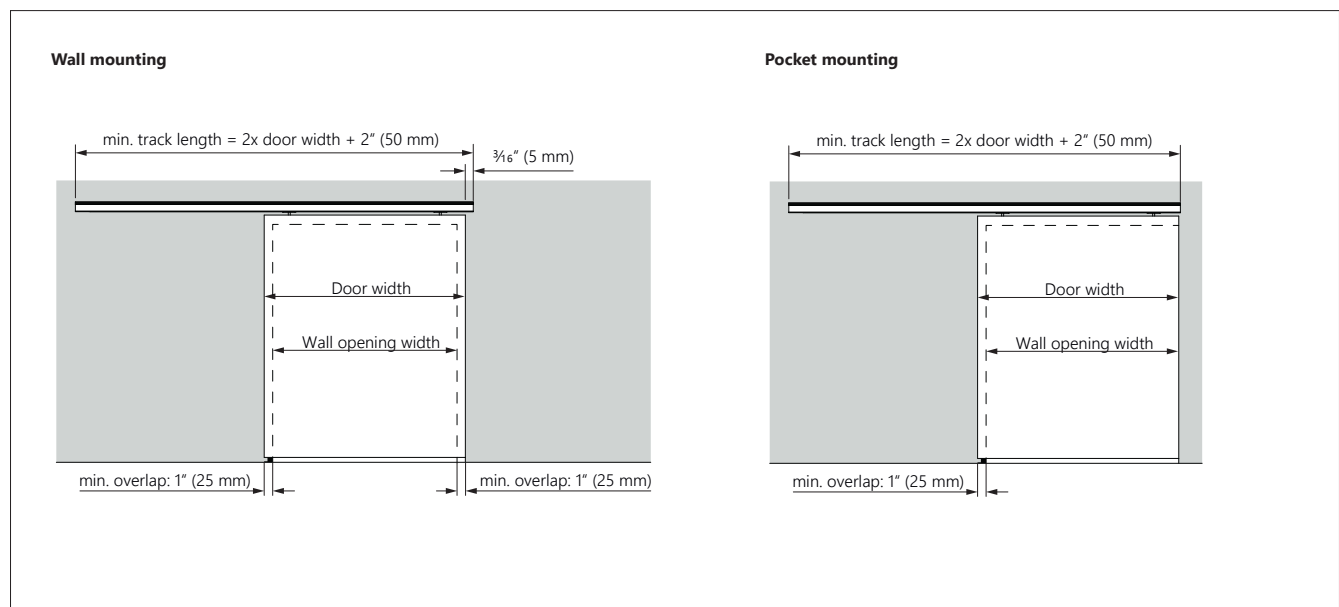

Sliding door hardware with recessed wood door mount

Side view

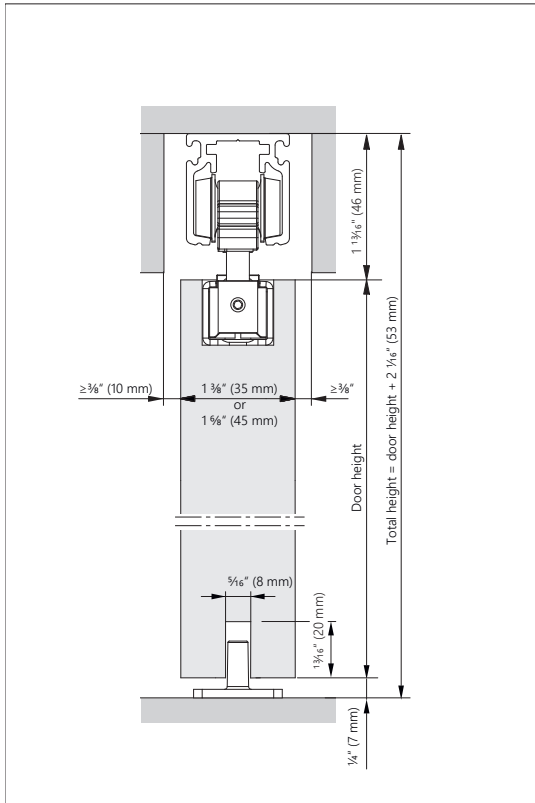

Front view

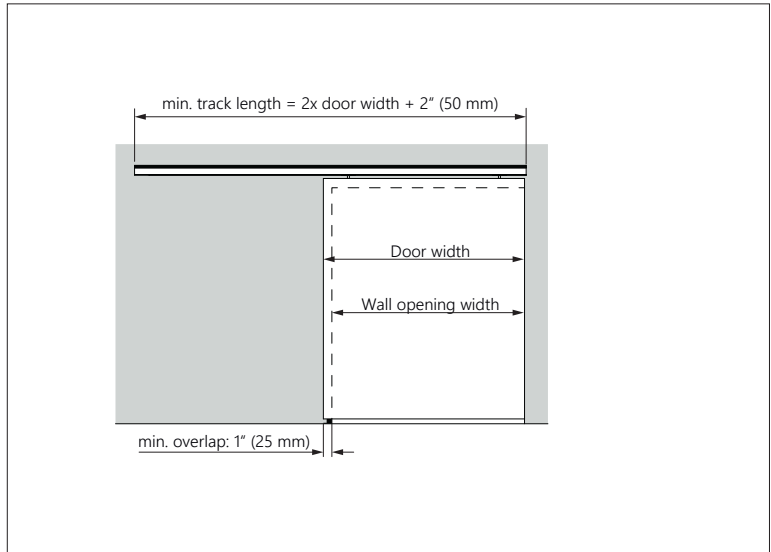

Drawings and formulas

Sliding door hardware with glass clamps

Side view

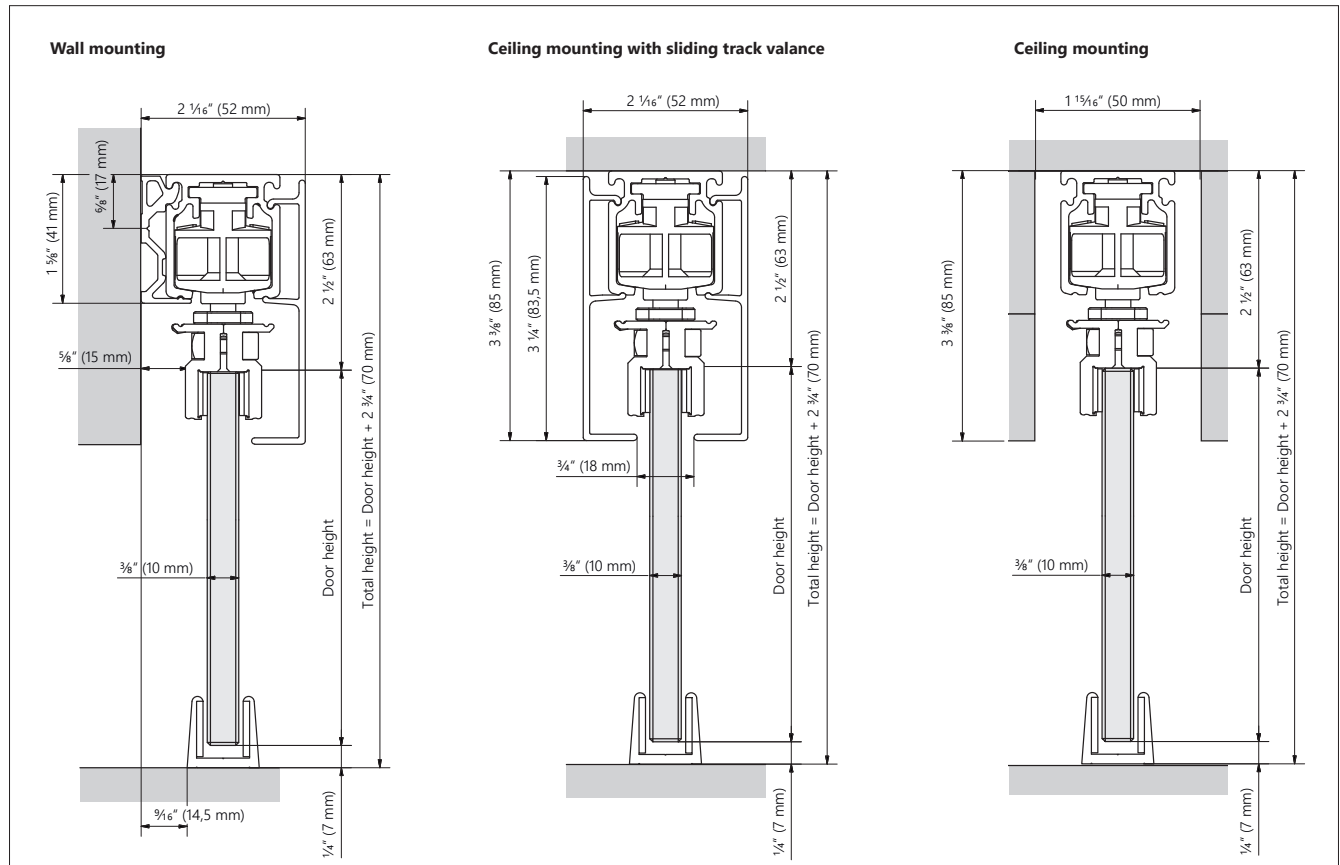

Front view

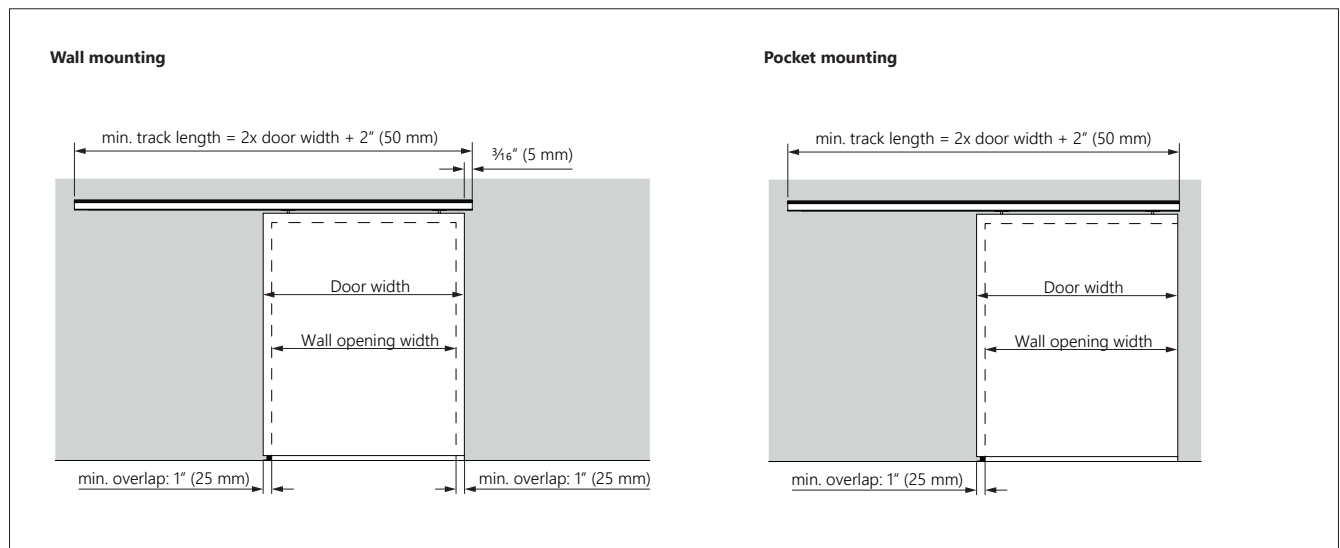

Sliding door hardware with glass door and clamps with valance

Side view

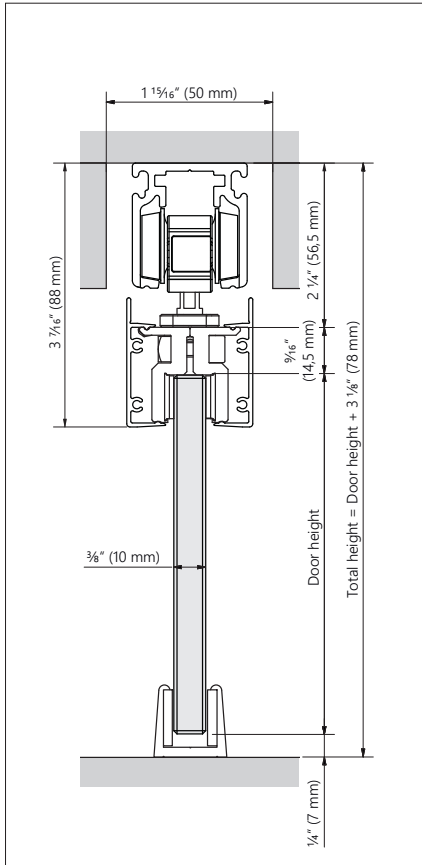

Front view

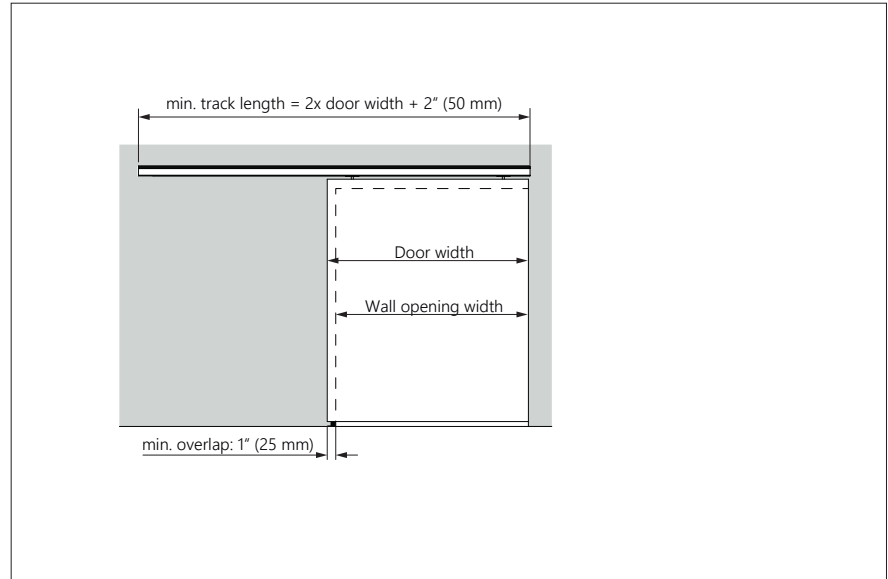

Make some notes

A large grid of small dots for taking notes, consisting of 20 columns and 30 rows of dots.

Make some notes

A large grid of small dots for taking notes, consisting of 20 columns and 30 rows of dots.

Make some notes

A large grid of small dots for taking notes, consisting of 20 columns and 30 rows of dots.



A brand of Bartels USA, Inc.

1901 Tigertail Blvd, Dania Beach, FL 33004

PH: 786 791 8557

E: sales@falkenstein-doors.com